



GP-SR1-PC200

Owner's Manual

Gobel Power LiFePO4 Battery

TABLE OF CONTENTS

1. INFORMATION ON THIS DOCUMENT	5
1.1. Validity.....	5
1.2. Target Group	5
1.3. Content and Structure of this Document	5
1.4. Levels of Warning Messages	5
1.5. Symbols in the Document.....	6
1.6. Designation in the Document.....	6
2. SAFETY	7
2.1. Intended Use.....	7
2.2. Important Safety Instructions.....	7
2.2.1. Battery Module Leakage.....	7
2.2.2. Firefighting Measures	8
2.2.3. Battery Modules Handling and Storage Guide	8
2.2.4. Warning of Overvoltages	9
2.2.5. Caution of Weight.....	9
2.2.6. Notice of Property Damage	9
3. SCOPE OF DELIVERY.....	10
4. BATTERY SYSTEM OVERVIEW	12



4.1.	Battery System Description.....	12
4.2.	Interface.....	12
4.3.	Symbols on the System.....	13
5.	INSTALLATION	14
5.1.	Requirements for Installation.....	14
5.1.1.	Requirements for Installation Location.....	14
5.1.2.	Tools.....	14
5.1.3.	Safety Gear.....	14
5.2.	Installation	15
6.	ELECTRICAL CONNECTION	18
6.1.	Overview of the Connection Area.....	18
6.2.	Connection Diagram.....	18
6.2.1.	One Battery Module.....	18
6.2.2.	Multiple Module	19
6.3.	Data Cable Connection	20
6.3.1.	Inverter Data Cable Connection.....	20
6.3.2.	Parallel Data Cable Connection	21
6.4.	DC Connection	22
7.	COMMISSIONING	24
7.1.	Configure the Battery System.....	24

7.2.	Switch on the Battery System	24
7.3.	Switch on and Commission the Inverter.....	24
8.	OPERATION.....	26
8.1.	Switch on the Battery System	26
8.2.	Switch off the Battery System	26
8.3.	Recommended Charging Method	26
9.	DECOMMISSIONING	27
10.	EXTENSION	28
11.	TROUBLESHOOTING	29
11.1.	LED Light Designation for Errors	29
11.2.	The battery system is not able to be turned on or off.....	29
12.	MAINTENANCE AND STORAGE	30
12.1.	Cleaning.....	30
12.2.	Maintenance	30
13.	DISPOSAL OF THE BATTERY SYSTEM	31
14.	TECHNICAL PARAMETERS	32



15.	CONTACT INFORMATION.....	34
16.	APPENDIX	35
16.1.	Configure BMS of Battery Module	35
16.2.	Explanation of Common Settings.....	39
16.2.1.	Read and Save History Data	39
16.2.2.	Parameters Sent to Inverters	40
16.2.3.	Parameters for Heating Pad.....	41
16.3.	ADS Table of DIP Switch.....	42
16.4.	Designation of RS232, RS485 and CAN Ports	43
16.4.1.	Designation of RS232 Port.....	43
16.4.2.	Designation of RS485 Port.....	43
16.4.3.	Designation of CAN Port.....	44
16.5.	LED Indicator.....	45

1. Information on this Document

1.1. Validity

This document is valid for the LiFePO₄ battery module GP-SR1-PC200.

1.2. Target Group

The instructions in this document may only be performed by qualified persons who must have the following skills:

- Knowledge of how batteries work and are operated
- Knowledge of how an inverter works and is operated
- Knowledge of, and adherence to the locally applicable connection requirements, standards, and directives
- Knowledge of, and adherence to this document and the associated system documentation, including all safety instructions
- Training in dealing with the hazards associated with the installation and operation of electrical equipment and batteries
- Training in the installation and commissioning of electrical equipment

Failure to do so will make any manufacturer's warranty, guarantee or liability null, and void unless

you can prove that the damage was not due to non-compliance.

1.3. Content and Structure of this Document

This document contains safety information and instructions, scope of delivery, battery system overview, installation, electrical connection, commissioning, operation, decommissioning, extension, troubleshooting, maintenance and storage, disposal of the battery system, technical parameters and contact information. Please finish reading this document before taking any actions on the battery system.

1.4. Levels of Warning Messages

 DANGER
Indicates a hazardous situation which, if not avoided, will result in death or serious injury.

**WARNING**

Indicates a hazardous situation which, if not avoided, could result in death or serious injury.

**CAUTION**

Indicates a hazardous situation which, if not avoided, could result in minor or moderate injury.

**NOTICE**

Indicates a situation which, if not avoided, can result in property damage.

1.5. Symbols in the Document

**QUALIFIED PERSON**

Sections describing activities to be performed by qualified persons only.

1.6. Designation in the Document

Battery System	GP-SR1-PC200
BMS	Battery Management System
SOC	State of Charge

2. Safety

2.1. Intended Use

The battery system is for residential and works with/without a photovoltaic system. It is a 51.2V LiFePO₄ battery storage system, with the control module on itself. It could be operated in on-grid and off-grid modes with compatible inverters.

The battery system could be connected to the PC through USB cable for maintenance and firmware updating.

The battery system must only be used as stationary equipment.

The battery system is suitable for indoor use only (or well protected place from raining, snow).

The battery system must only be operated in connection with a compatible inverter. The list of these inverters could be found at www.gobelpower.com.

The battery system is not suitable for supplying life-sustaining medical devices. Please ensure that no personal injury would lead due to the power outage of the battery system.

Alterations to the battery system, e.g., changes or modifications are not allowed unless the written permission of Gobel Power is achieved. Unauthorized alterations will void the guarantee and warranty claims. Gobel Power shall not be held liable for any damage caused by such changes.

The type label should always be attached to the battery system.

2.2. Important Safety Instructions

The battery system has been designed and tested in accordance with international safety requirements. However, in order to prevent personal injury and property damage and ensure long-term operation of the battery system, please do read this section carefully and observe all safety information at all times.

2.2.1. Battery Module Leakage

If the battery modules leak electrolytes, contact with the leaking liquid or gas should be avoided. The electrolyte is corrosive, and the contact may cause skin irritation and chemical burns. If one is exposed to the leaked substance, do these actions:

Inhalation: Evacuate the contaminated area, and seek medical help immediately.



Eye contact: Rinse eyes with flowing water for 15 minutes and seek medical help immediately.

Skin contact: Wash the affected area thoroughly with soap and water and seek medical help immediately.

Ingestion: Induce vomiting and seek medical help immediately.

2.2.2. Firefighting Measures

The battery modules may catch fire when it is put into the fire. In case of a fire, please make sure that an ABC or carbon dioxide extinguisher is nearby. Water cannot be used to extinguish the fire.

Full protective clothing and self-contained breathing apparatus are required for the firefighters to extinguish the fire.

2.2.3. Battery Modules Handling and Storage Guide

The battery modules and its components should be protected from damage when transporting and handling.

- Do not impact, pull, drag, or step on the battery modules.
- Do not insert unrelated objects into any part of the battery modules.
- Do not throw the battery module into a fire.
- Do not soak the battery modules in water or seawater.
- Do not expose to rain or snow.
- Do not expose to strong oxidizers.
- Do not short circuit the battery modules.
- The battery modules cannot be stored at high temperatures (more than 50°C).
- The battery modules cannot be stored directly under the sun.
- The battery modules cannot be stored in a high humidity environment.
- Do not use the battery modules if it is defective, or appears cracked, broken or otherwise damaged, or fails to operate.
- Do not attempt to open, disassemble, repair, tamper with, or modify the battery modules. The battery modules are not user-serviceable.
- Do not use cleaning solvents to clean the battery modules.

2.2.4. Warning of Overvoltages

DANGER

Danger to life due to electric shock in case of overvoltages and if surge protection is missing

Overvoltages (e. g. in the event of a flash of lightning) can be further conducted into the building and to other connected devices in the same network via the network cables or other data cables if there is no surge protection. Touching live parts and cables results in death or lethal injuries due to electric shock.

- Ensure that all devices in the same network and the inverter are integrated into the existing surge protection.
- When laying the network cables or other data cables outdoors, it must be ensured that a suitable surge protection device is provided at the transition point of the cable from the inverter outdoors to the inside of a building.

2.2.5. Caution of Weight

CAUTION

Risk of injury due to weight of the battery module

Injuries may result if the battery module is lifted incorrectly or dropped while being transported or installed.

- Transport and lift the battery module carefully. Take the weight of the battery module into account.
- Wear suitable personal protective equipment for all work on the battery system.

2.2.6. Notice of Property Damage

NOTICE

Damage to the battery system due to under voltages

- If the battery system doesn't start at all, please contact Gobel Power after-sales service within 48 hours.

3. Scope of Delivery

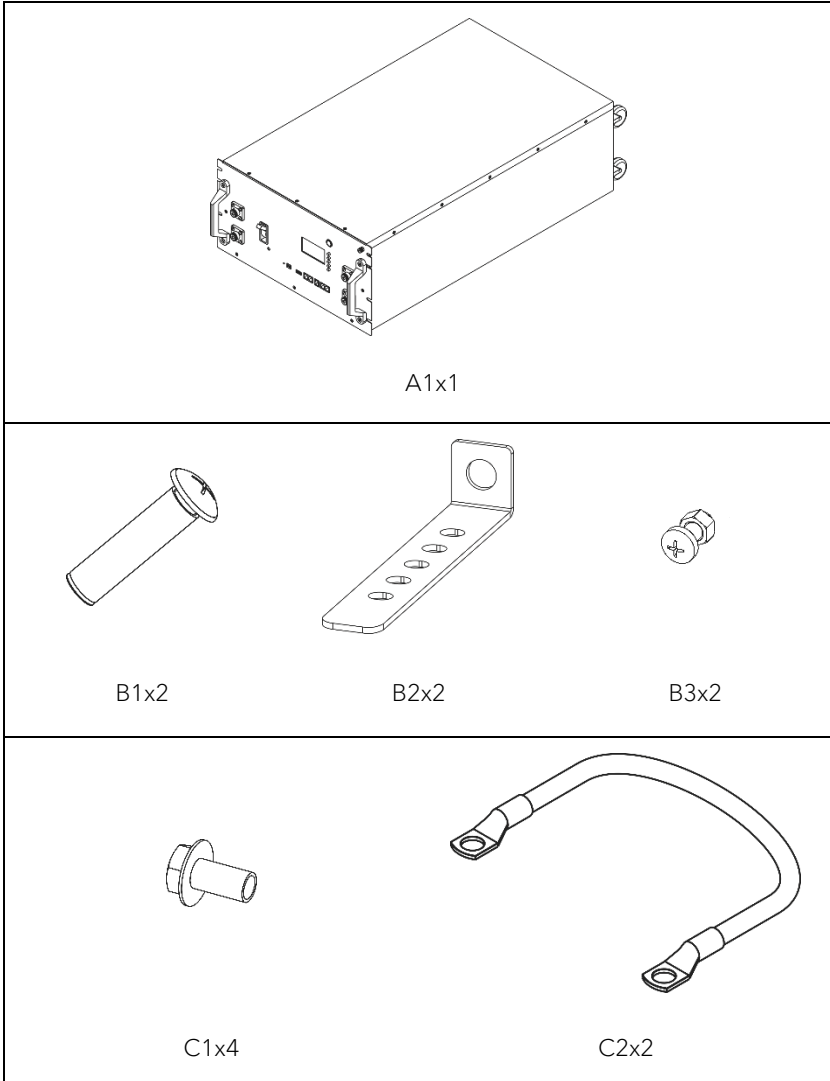

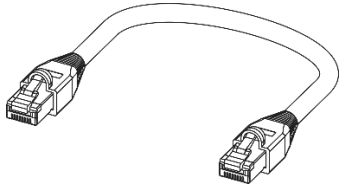
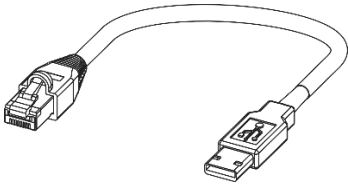
			
D1x1		D2x1	
A1	Battery Module		
B1	M6-60 Expanding Screw		
B2	Wall Fixture		
B3	M6 Screw and Nuts		
C1	M8 Screw		
C2	DC Power Cable (1m, M8)		
D1	Inverter/Parallel Communication Cable		
D2	BMS to Computer Communication Cable		



4. Battery System Overview

4.1. Battery System Description

The GP-SR1-PC200 is used as a connected battery for the intermediate storage of excess PV energy in an inverter system.







It has a built in BMS. The parameters and instruction of BMS could be read on the Appendix 16.2. The battery system could support the backup function of inverters and is compatible with both 1 and 3 phase inverters.

WHEN BATTERY SYSTEMS ARE IN PARALLEL CONNECTION, UP TO 15 BATTERY MODULES COULD BE CONNECTED IN PARALLEL.

4.2. Interface

+	DC Positive
-	DC Negative
ADD	Address Dial for parallel connection
RST	Reset BMS
DCT	Dry Contact
CAN	CAN Port for inverter communication
RS485A	RS485 Port for inverter communication
RS485B/RS485C	RS485 Port for parallel connection
RS232	Connection Port for PC communication
250A Breaker	Circuit Breaker, cut off circuit while current >250A
Push to Trip	Push to test the Breaker
On/Off	Power Button, press down to power on

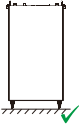
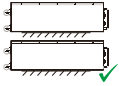
4.3. Symbols on the System

	<p>Grounding Conductor</p> <p>This symbol indicates the position for connecting a grounding conductor.</p>	
	<p>WEEE Designation</p> <p>Do not dispose of the system together with the household waste but in accordance with the disposal regulations for electronic waste applicable at the installation site.</p>	
	<p>Keep dry.</p>	
	<p>Keep the battery modules away from children.</p>	
	<p>Beware of electrical voltage.</p>	
	<p>Allowed Installation/Storage Method</p> <p>Stand on floor.</p>	<p>Other position is not allowed for long term storage</p>
	<p>Allowed Installation/Storage Method</p> <p>Each module mounted on the rack.</p>	
	<p>With Heating Pad</p>	

5. Installation

5.1. Requirements for Installation

5.1.1. Requirements for Installation Location

- a) A solid support surface must be available (e.g., concrete or masonry).
- b) The installation location must be inaccessible to children.
- c) The installation location must be suitable for the weight and dimensions of the battery system.
- d) The installation location must not be exposed to direct solar irradiation.
- e) The installation location must not be close to the fire.
- f) The installation location must not be exposed to rain or snow.
- g) The altitude of the installation location should be less than 3000m.
- h) The ambient temperature should be between -10°C and +50°C.
- i) The ambient humidity should be between 5-95%.

5.1.2. Tools

The tools in the following table could be needed during the installation.

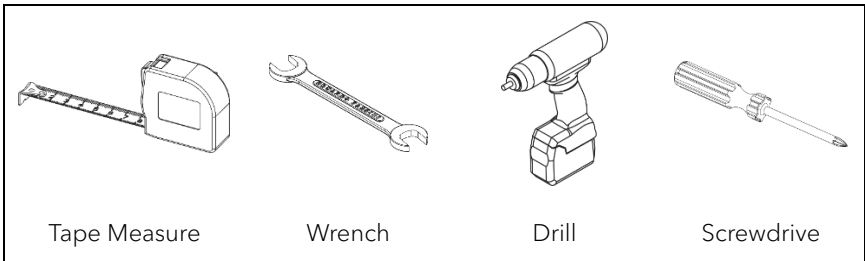

5.1.3. Safety Gear

It is recommended to wear the following safety gear when dealing with the battery system.



Gloves



Safety Shoes



Safety Goggles

5.2. Installation



QUALIFIED PERSON



CAUTION

Risk of injury due to weight of the battery module

Injuries may result if the battery module is lifted incorrectly or dropped while being transported or installed.

- Transport and lift the battery module carefully. Take the weight of the battery module into account.
- Wear suitable personal protective equipment for all work on the battery system.

Procedure:

1. Take out Battery Module (A1) and make it stand on the floor.

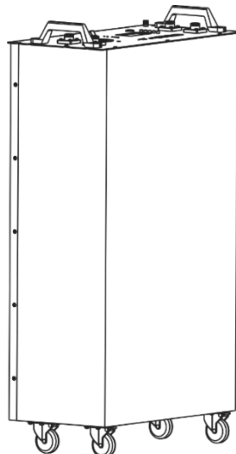

2. Drill two M10-60mm holes on the wall. Distance between two holes is 470mm. Distance between hole and floor is 823.3mm.

Then fix Wall Fixture (B2) on the wall with Expanding Screws (B1).

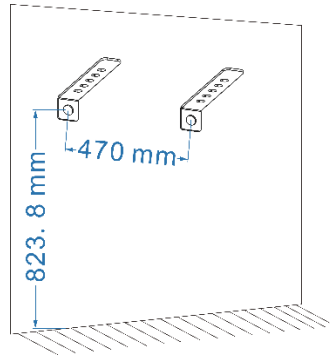

3. Push up locks on the wheels to unlock.

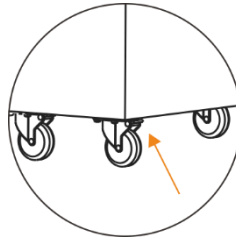

4. Move Battery Module (A1) to the place between two Wall Fixtures (B2).

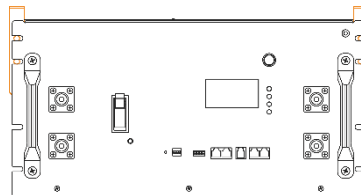

5. Use M6 Screws and Nuts (B3) to fix Battery Module (A1) on the Wall Fixtures (B2).

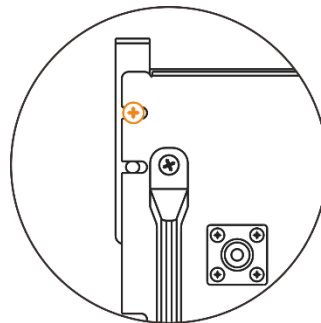

6. Push down locks on the wheels to lock.

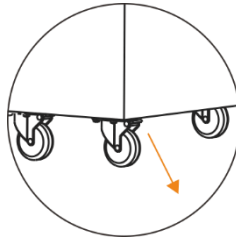



6. Electrical Connection

6.1. Overview of the Connection Area

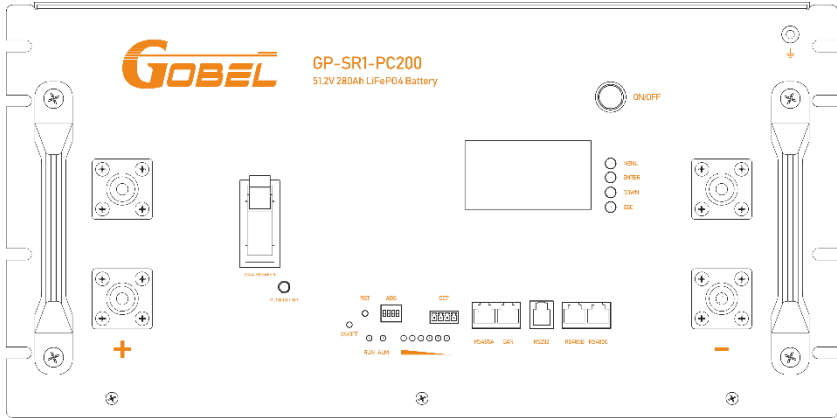

6.2. Connection Diagram

6.2.1. One Battery Module

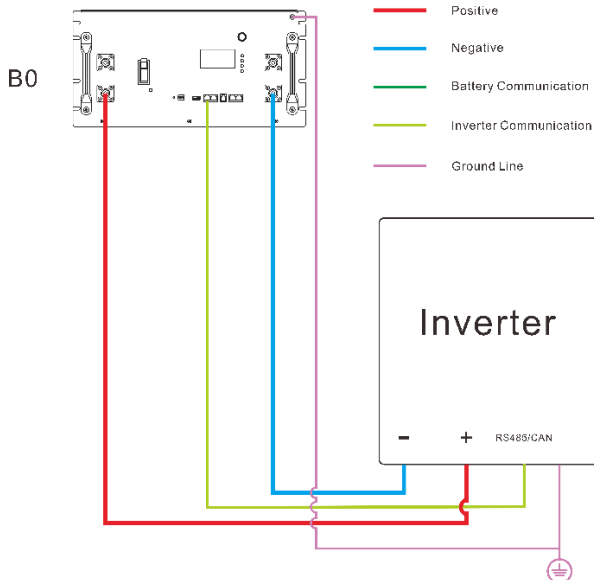

Turn ADS to [ON,OFF,OFF,OFF].

6.2.2. Multiple Module

If total Charge Current and Discharge Current is below 200A:

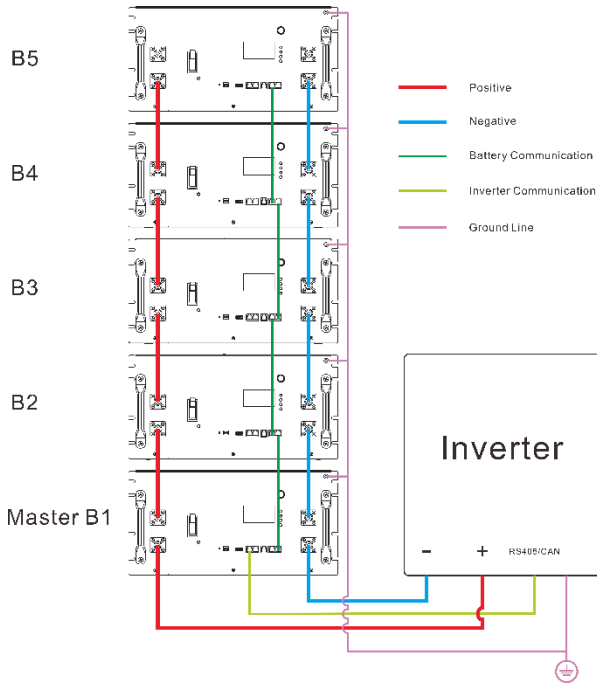

Turn ADS of each Battery Module to correspondent address according to Appendix 16.2.

If total Charge Current or Discharge Current is above 200A: Use external busbars which support total Charge Current or Discharge Current.

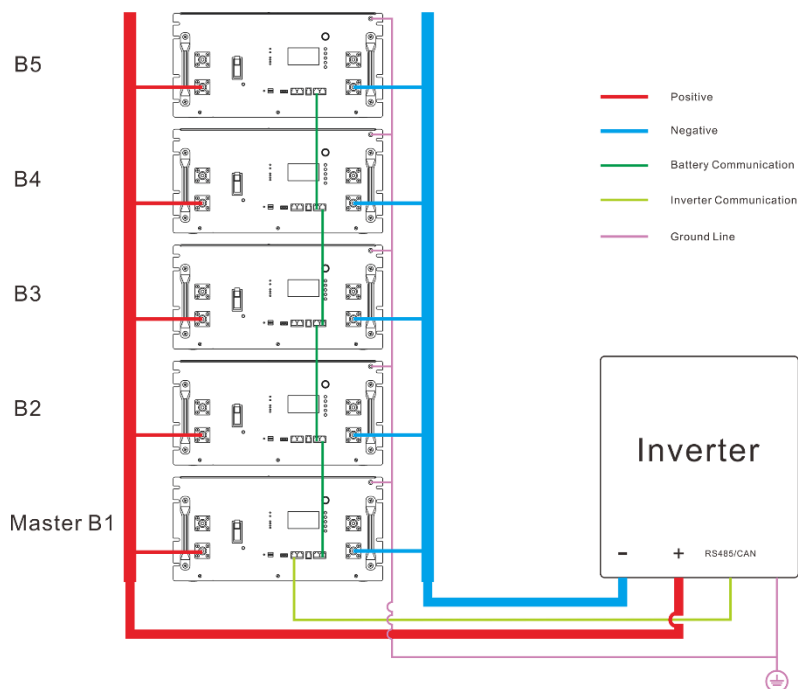

6.3. Data Cable Connection

QUALIFIED PERSON

6.3.1. Inverter Data Cable Connection

Additionally required mounting material:

One data cable (D1)

Data cable requirements:

The cable length and quality affect the quality of the signal. Observe the following cable requirements.

- Cable category: Cat5, Cat5e or higher
- Plug type: Metal Shielded RJ45 of Cat5, Cat5e or higher

- Shielding: Yes
- UV-resistant for outdoor use
- Straight- through wired cables

Maximum cable length: 10 m.

Procedure:

1. Read the designation of the INVERTER port on Appendix 16.3 and the inverter manual and decide whether to modify the data cable.

The designation of INVERTER port on Battery Module could be read in Appendix 16.3.

Note: Please read the inverter manufacture's manual, take it into account.

If the data cable must be modified (such as Victron need Type A Cable), please cut the cable, arrange the wire positions, and crimp the RJ45 connector with a network wire clamp.

2. Plug data cable to CAN or RS485A port. Proper protocol should be chosen in PC software.
3. If only one Battery Module, Turn ADS of the module to [ON, OFF, OFF, OFF]. If several Battery Modules parallelly connected, turn ADS of the master module to [ON, OFF, OFF, OFF] and connect inverter with master module.

6.3.2. Parallel Data Cable Connection

Additionally required mounting material (not included in the scope of delivery):

One data cable (D1)

Data cable requirements:

The cable length and quality affect the quality of the signal. Observe the following cable requirements.

- Cable category: Cat5, Cat5e or higher
- Plug type: Metal Shielded RJ45 of Cat5, Cat5e or higher
- Shielding: Yes
- UV-resistant for outdoor use
- Straight- through wired cables
- Maximum cable length: 10 m.

Procedure:

1. Plug the RJ45 connector to the RS485B port of one Battery Module.
2. Plug the other side of RJ45 connector to the RS485C port of another Battery Module.
3. Turn ADS of each Battery Module to correspondent address according to Appendix 16.2.

6.4. DC Connection



QUALIFIED PERSON

When multiple Battery Modules are connected, the positive power cable length for all the Battery Modules should be approximately equal, and so are the negative power cables. A junction box is needed to combine these cables. Please follow the local, state, provincial, federal, or national laws, regulations, and instructions from the inverter manufacturer to choose the right junction box.

Additionally required mounting material:

Two M8 DC Power Cables (C2)

Cable requirements:

- Conductor cross-section: 35mm. Please choose the correct one according to application and also the requirements of the inverter manufacturer.
- Maximum cable length: 10 m

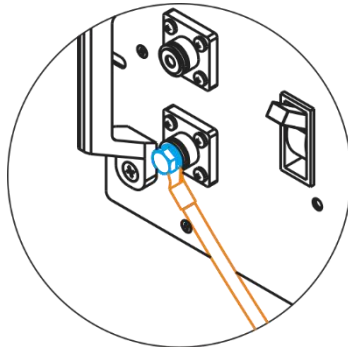

Procedure

1. Turn Circuit Breaker Off.
2. Remove the protective covers on the terminals of Battery Module.

3. Use M8 Screw (C1) to connect Red Power Cable (C2) with any of two positive (+, Red) terminals of Battery Module.
4. Use M8 Screw (C1) to connect Black Power Cable (C2) with any of two negative (-, Black) terminals of Battery Module.
5. Mount protective covers on the terminals of Battery Module.

7. Commissioning

7.1. Configure the Battery System



QUALIFIED PERSON

1. Switch off the Circuit Breaker of Battery Module.
2. Disconnect Communication Cable with inverter.
3. Press down the ON/OFF button of Battery Module.
4. Plug RJ12 terminal of BMS to PC Communication Cable (D2) in RS232 port of Battery Module and connect USB terminal with computer. Open Gobel PC BMS Tools software and set communication protocol according to inverter. Please check detailed instructions in Appendix.

7.2. Switch on the Battery System



QUALIFIED PERSON

Requirements:

- The power cable connection between the battery system and the inverter is switched off.
- The inverter must be correctly mounted.
- All cables must be correctly connected.

Procedure:

1. Switch on the air switch (circuit breaker) between the battery and inverter if there is any.
2. Switch on the Circuit Breaker of Battery Module.
3. Press down the ON/OFF button of Battery Module.

7.3. Switch on and Commission the Inverter



QUALIFIED PERSON

Procedure:

1. Mount and connect the inverter according to the inverter manufacturer's instruction.
2. Commission and configure the inverter according to the inverter

manufacturer's instruction.

If the battery information could be read correctly, it means the connection between the battery system and the inverter is all right, and the battery system is ready to work.



8. Operation

8.1. Switch on the Battery System

To make sure the battery system can work well with the inverter, please follow the right procedure to start them.

The procedure is:

- 1) turn on the switch between the inverter and battery if there is any;
- 2) switch on the battery system;
- 3) switch on the inverter.

8.2. Switch off the Battery System

The procedure to switch off the battery system is:

- 1) switch off the inverter;
- 2) switch off the battery;
- 3) switch off the air switch between the battery and the inverter if there is any.

The way to switch off the battery system is to press the ON/OFF Button on the Battery Module.

8.3. Recommended Charging Method

Standard Charge: Constant current charging with a voltage of 55.2V and a current of 0.25C (A) until the current cut-off 14A.

Fast Charge: Constant current charging with a voltage of 55.2V and a current of 0.5C (A) until the current cut-off 14A.

9. Decommissioning



QUALIFIED PERSON



CAUTION

Risk of injury due to weight of the battery module

Injuries may result if the battery module is lifted incorrectly or dropped while being transported or installed.

- Transport and lift the battery module carefully. Take the weight of the battery module into account.
- Wear suitable personal protective equipment for all work on the battery system.

Procedure:

1. Shut off the inverter.
2. Switch off the battery system.
3. Switch off the breaker between the inverter and the battery system if there is any.
4. Disconnect the DC cables between inverter and the battery system, PE, and data cable among battery system, inverter.
5. Loosen the screws on fixtures between battery module and the wall. And then take off the fixtures.

If the battery system is to be stored or shipped, pack the system. Use the original packaging or packaging that is suitable for the weight and dimensions of the system.

Dispose of the battery system in accordance with the locally applicable disposal regulations for electronic waste.



10. Extension

The battery system could be extended at any time. The original SOC of the new battery module is around 40%. Max 15 battery modules are allowed to be connected parallelly.

Procedure:

1. Shut off the inverter.
2. Switch off the battery system.
3. Switch off the breaker between the inverter and the battery system if there is any.
4. Add the new module and connect it with other battery modules.
5. Switch on the breaker between the inverter and the battery system if there is any.
6. Switch on and configure the battery system.
7. Start the inverter.

11. Troubleshooting

11.1. LED Light Designation for Errors

Please check Appendix 16.4 for detailed information.

11.2. The battery system is not able to be turned on or off

Contact with Gobel Power after-sales service.



12. Maintenance and Storage

12.1. Cleaning

It is recommended that the battery system be cleaned periodically. If the enclosure is dirty, please use a soft, dry brush or a dust collector to remove the dust. Liquids such as solvents, abrasives, or corrosive liquids should not be used to clean the enclosure.

12.2. Maintenance

The battery module should be stored in an environment with a temperature range between -10°C ~ $+50^{\circ}\text{C}$, and charged regularly according to the table below with no more than 0.5 C (A C-rate is a measure of the rate at which a battery is discharged relative to its maximum capacity.) to the SOC of 40% after a long time of storage.

Storage environment temperature	Relative humidity of the storage environment	Storage time	SOC
Below -10°C	/	Not allowed	/
$-10\sim 25^{\circ}\text{C}$	5%~70%	≤ 12 months	$25\%\leq\text{SOC}\leq 60\%$
$25\sim 35^{\circ}\text{C}$	5%~70%	≤ 6 months	$25\%\leq\text{SOC}\leq 60\%$
$35\sim 50^{\circ}\text{C}$	5%~70%	≤ 3 months	$25\%\leq\text{SOC}\leq 60\%$
Above 50°C	/	Not allowed	/

13. Disposal of the Battery System

Disposal of the system must comply with the local applicable disposal regulations for electronic waste and used batteries.

- Do not dispose of the battery system with your household waste.
- Avoid exposing the batteries to high temperatures or direct sunlight.
- Avoid exposing the batteries to high humidity or corrosive atmospheres.
- For more information, please contact Gobel Power.



14. Technical Parameters

Battery Module	GP-SR1-PC200
Number of Modules	1
Usable Energy [1]	14.3 kWh
Max Output Current [2]	200 A
Dimensions (H/W/D)	771.5 x 482.6 x 241 mm
Weight	118 kg
Nominal Voltage	51.2 VDC
Operating Voltage	44-55.2 VDC
Operating Temperature	-20 °C to +55°C
Battery Cell Technology	Lithium Iron Phosphate (cobalt-free)
Communication	RS232, RS485, CAN
Enclosure Protection Rating	IP21
Round-Trip Efficiency	≥95%
Scalability	Max. 15 Modules in Parallel (215 kWh)
Certification	CE, IEC 62619, UN 38.3
Applications	ON Grid / ON Grid + Backup / OFF Grid
Warranty [2]	10 Years
Compatible Inverters	Refer to Gobel Power PC-BMS Inverter Compatible List



[1] DC Usable Energy, Test conditions: 100% DOD, 0.5 charge & discharge at + 25 °C. System Usable Energy may vary with different inverter brands.

[2] Conditions apply. Refer to Gobel Power Limited Warranty.



15. Contact Information

Gobel Power Global Service

service@gobelpower.com

WhatsApp: +86-13684942767

Address: No.829, XinHu Road 2140, BaoAn, Shenzhen, 518000, China

<https://www.gobelpower.com>

16. Appendix

16.1. Configure BMS of Battery Module

Additionally required mounting material:

1. Data Cable (D2)
2. Gobel PC BMS Tools Software
3. Windows OS PC (In Control Panel -> Regions, change Format to English (United States), otherwise, settings may not be saved successfully. DO NOT use Customize Format.)

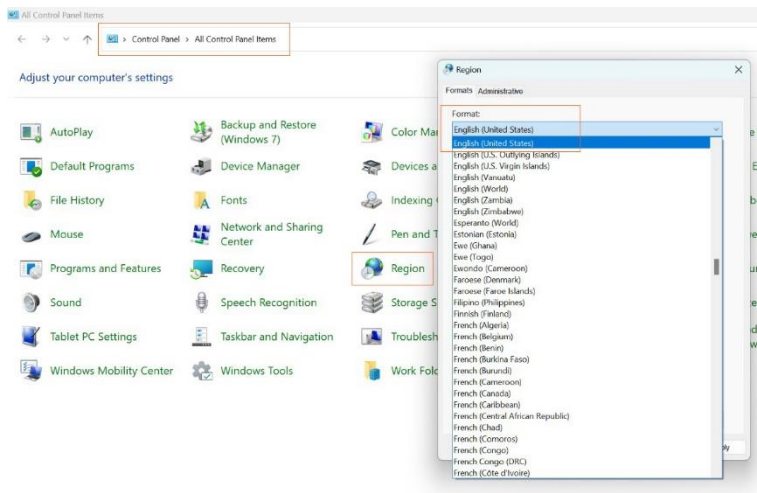

Cable requirements:

- RS232 to USB data cable (RJ12 Port to USB Port)
- Read the designation of the RS232 port of Battery Module in Appendix 16.3, and decide whether to modify the third party data cable.

Software Download Link:

<https://drive.google.com/drive/folders/1gtvpa5KrnvjjpLQg6N6t3jck1SYNv0gq?usp=sharing>

Procedure:

1. Press down ON/OFF button of Battery Module.
2. Plug RJ12 terminal of Data Cable in RS232 port of Battery Module, plug

USB terminal of Data Cable in PC.

3. PC will install driver automatically.
4. Open "PbmsTools.exe" of Gobel PC BMS Tools Software.

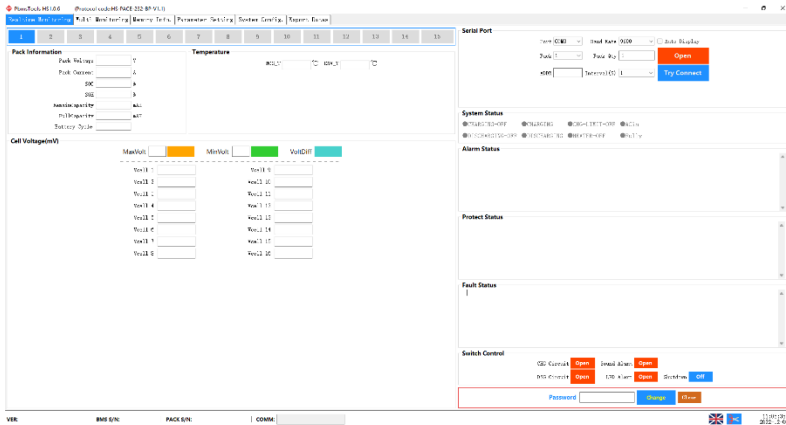

5. If connected successfully, a serial port will be detected. If no Serial port is detected, please check if Data Cable is connected well or Driver is installed successfully, or a valid Data Cable is used.

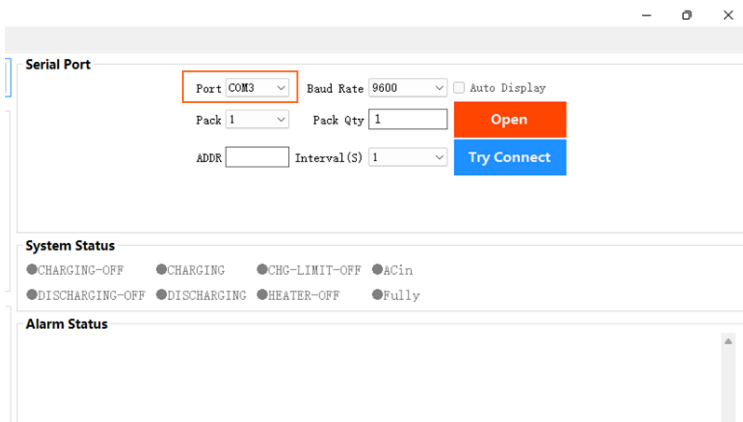

6. Click Open and Try Connect to establish communication with BMS of Battery Module.

Serial Port

Port: Baud Rate: Auto Display

Pack: Pack Qty:

ADDR: Interval (S):

Open
Try Connect

System Status

CHARGING-OFF
 CHARGING
 CHG-LIMIT-OFF
 ACin
 DISCHARGING-OFF
 DISCHARGING
 HEATER-OFF
 Fully

Alarm Status

7. If communication is established successfully, Battery Module data will be shown in the monitor.

8. In System Config. tab -> Inverter Protocol section, click Read to get default settings.

The screenshot shows the 'System Config.' tab in the software. The 'Inverter protocol' section is highlighted with a red box. It contains the following fields and buttons:

- CAN Protocol:
- RS485 Protocol:
- Type:
- Buttons: Read Write

Other visible sections include:

- Capacity (mAh):** Real Capacity, Full Capacity, Buttons: Read Write
- Battery Cycle Setting:** Battery Cycle: Setting
- Manufacture Information:**
 - Clear text box after printing
 - no-repeat: 300 S/N Write
 - no-repeat: FACE 3/N (20) Write



9. Choose proper Inverter Protocol from CAN or RS485 dropdown menu according to inverter.

Inverter protocol

CAN Protocol

RS485 Protocol

Type

Manufacture Information

Clear text box after writing

no-repeat RMS S/N

FACE_CAN
PYLON_CAN
GROWATT_CAN
VICTRON_CAN
SE_CAN
LUXPOWER_CAN
SRD_CAN
SMA_CAN
GOODWE_CAN
STUDER_CAN
SOFAR_CAN
PV_CAN

10. Click Write to save settings. After save, click Read to check if settings are saved successfully.

Inverter protocol

CAN Protocol

RS485 Protocol

Type

Read Write

16.2. Explanation of Common Settings

16.2.1. Read and Save History Data

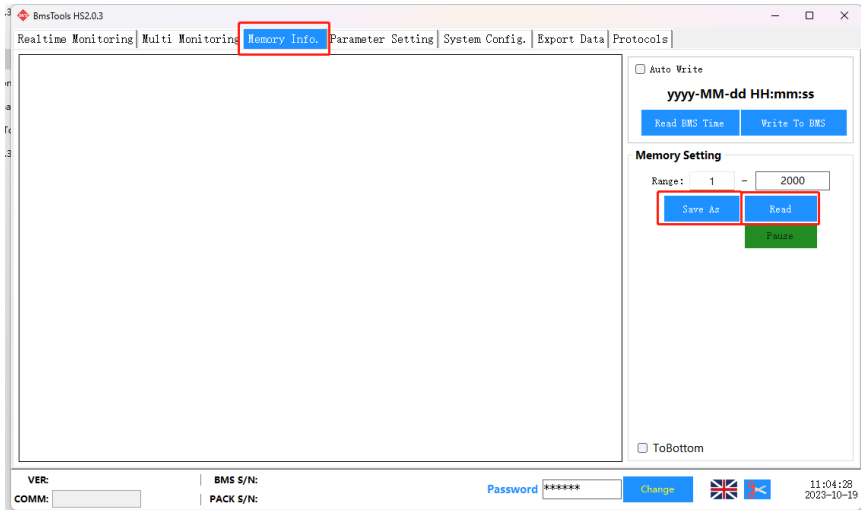

In Memory Info. Tab, click Read and Save As to export history data as Excel File. This data is important for aftersale service.



16.2.2. Parameters Sent to Inverter

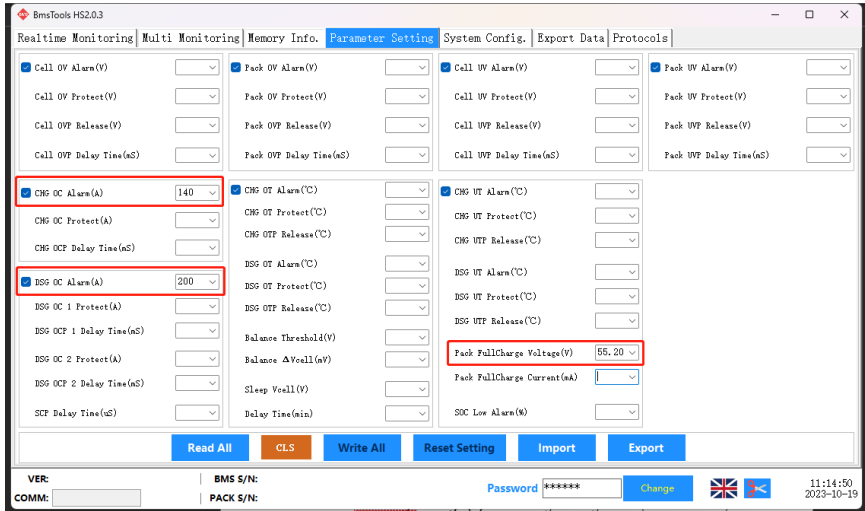

Some important values are sent to inverter, such as:

- A. **CHG OC Alarm (A)** : Max Charge Current Limit (CCL in Victron)
- B. **DSC OC Alarm (A)**: Max Discharge Current Limit (DCL in Victron)
- C. **Pack FullCharge Voltage (V)**: Max Charge Voltage Limit (CVL in Victron)

Upon establishing a connection with the inverter, kindly verify whether the parameters within the inverter correspond with those present in the BMS.

16.2.3. Parameters for Heating Pad

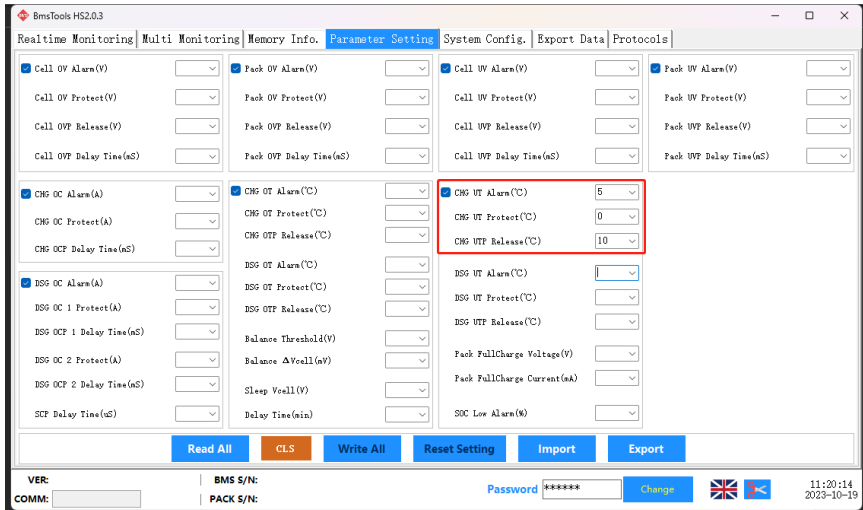

If a heating pad is present within the battery, these parameters will govern the activation and deactivation of the heating pad.

- A. **CHG UT Alarm (°C):** The heating pad will be activated when the temperature falls below this threshold during the charging process.
- B. **CHG UTP Release (°C):** The heating pad will be deactivated if the temperature exceeds this threshold during the charging process.

The heating pad is automatically activated/deactivated by the BMS. The heating pad draws power from the charger/inverter, rather than the battery.

16.3. ADS Table of DIP Switch

DIP Switch allocates each Battery Module a unique id. It is needed for communication with inverter and communication between parallelly connected Battery Modules.

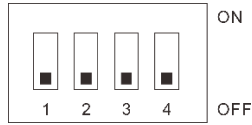

Address	1#	2#	3#	4#	Battery
0	OFF	OFF	OFF	OFF	No Parallel
1	ON	OFF	OFF	OFF	Master B1
2	OFF	ON	OFF	OFF	B2
3	ON	ON	OFF	OFF	B3
4	OFF	OFF	ON	OFF	B4
5	ON	OFF	ON	OFF	B5
6	OFF	ON	ON	OFF	B6
7	ON	ON	ON	OFF	B7
8	OFF	OFF	OFF	ON	B8
9	ON	OFF	OFF	ON	B9
10	OFF	ON	OFF	ON	B10
11	ON	ON	OFF	ON	B11
12	OFF	OFF	ON	ON	B12
13	ON	OFF	ON	ON	B13
14	OFF	ON	ON	ON	B14
15	ON	ON	ON	ON	B15

* For single battery module, if Address 0 cannot communicate with inverter, use Address 1 instead.

16.4. Designation of RS232, RS485 and CAN Ports

16.4.1. Designation of RS232 Port

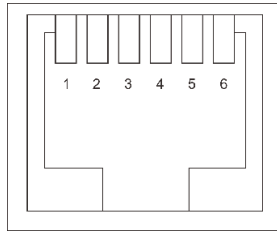

RS232: 6P6C RJ12 Terminal	
RJ12 Foot	Definition
2	NC
3	TX
4	RX
5	GND

16.4.2. Designation of RS485 Port

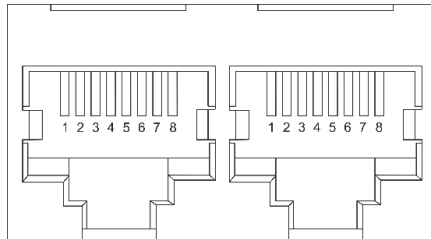

RS485: 8P8C RJ45 Terminal	
RJ45 Foot	Definition
1,8	B
2,7	A
3,6	GND
4,5	NC

16.4.3. Designation of CAN Port

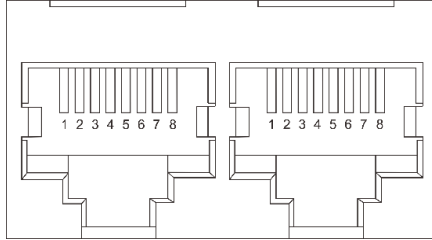

CAN: 8P8C RJ45 Terminal	
RJ45 Foot	Definition
1,2,3,7,8	NC
4	CANH
5	CANL
6	GND

16.5. LED Indicator

There are 9 LEDs, 1 for Alarm, 1 for Run, 1 for On, 6 for Capacity.

● is solid lights, ▲ is flashing lights (0.25s-3.75s), ◆ is flashing lights (0.5s-0.5s), ★ is flashing lights (0.5s-1.5s).

Action	State	State Lights			SOC Lights							
		ON	RUN	ALM	6	5	4	3	2	1		
Off	Sleep	/	/	/	/	/	/	/	/	/	/	
Standby	Normal	●	▲	◆	On according to SOC							
	Alarm	●	▲	★	On according to SOC						Low Voltage	
Charge	Normal	●	●	/	On according to SOC						ALM ● while Over Voltage Alarm	
	Alarm	●	●	★	Top SOC LED ◆							
	Over Charge Protection	●	●	/	●	●	●	●	●	●		
	Temperature, Over Current, Faulty Protection	●	/	●	/	/	/	/	/	/		Stop Charge
Dis-Charge	Normal	●	★	/	According to SOC							
	Alarm	●	★	★	According to SOC							
	Over Discharge Protection	●	/	/	/	/	/	/	/	/		Stop Discharge
	Temperature, Over Current, Short Circuit, Reverse Connection, Faulty Protection	●	/	●	/	/	/	/	/	/		Stop Discharge
Faulty	Faulty	/	/	●	/	/	/	/	/	/		Stop Charge & Discharge



SOC	Charge SOC Light						Discharge SOC Lights					
	6	5	4	3	2	1	6	5	4	3	2	1
0-16.6%	/	/	/	/	/	★	/	/	/	/	/	●
16.6-33.2%	/	/	/	/	★	●	/	/	/	/	●	●
33.2-49.8%	/	/	/	★	●	●	/	/	/	●	●	●
49.8-66.4%	/	/	★	●	●	●	/	/	●	●	●	●
66.4-83%	/	★	●	●	●	●	/	●	●	●	●	●
83-100%	★	●	●	●	●	●	●	●	●	●	●	●